

DMX Light Line



DMX LIGHT LINE DMX Light Line 18mm

FEATURES

- These DMX linear can be installed on the facade or in the ground of shopping center, bank and bridge, etc.
- Top brand Glue for better heatconduction, strong temperature withstand and perfect waterproof performance.
- High-brightness IPX6 SMD LED are assembled in this fixture.
- Apply solid capacitor of PCB for long life time.
- Save 40% power with more efficient power management design.
- Wide working voltage range DC12V-DC24V.
- Standard DMX512 control protocol (Max 44frames /second).
- DMX address can be set automatically and memorized also.
- The communication between led fixtures are synchronized perfectly under support of Artnet Controller.
- Protection: Hot pugging, and reverse connection.

DL186001 – DL181202 – DL186003 – DL186004

DMX LIGHT LINE 18mm



DLMS186003

DMX LIGHT LINE 18mm



SPECIFICATIONS

	DL186001	DL181202	DL186003	DL186004	DLMS186003
Size	1000x18x19 mm	1000x18x19 mm	1000x18x19 mm	1000x18x19 mm	1000x18x38 mm
Color	White2700K-5700K	Dynamic White 2700K-6000K	RGB	RGBW	RGB
Led	SDM 5050	SDM 5050	SDM 5050	SDM 5050	SDM 5050
Led Q.ty	60	120	60	60	60
View angle	120°	120°	120°	120°	120°
Voltage	24V DC	24V DC	24V DC	24V DC	24V DC
Power	12W	12W	12W	12W	12W
Control	On-Off/DMX 512	DMX 512	DMX 512	DMX 512	DMX 512
Address Setting	Auto/Manual	Auto/Manual	Auto/Manual	Auto/Manual	Auto/Manual
Pixel/m	1/2/4/5/10/20	1/2/4/5/10	1/2/4/5/10/20	1/2/4/5/10	1/2/4/5/10
Housing Color	Silver	Silver	Silver	Silver	Silver
Diffuser	Clear PC/ Dome Opal PC	Clear PC/ Dome Opal PC	Clear PC/ Dome Opal PC	Clear PC/ Dome Opal PC	Clear PC/ Dome Opal PC
Cable Entry	Bottom	Bottom	Bottom	Bottom	Bottom
Operating Temp	-20° to 50°C	-20° to 50°C	-20° to 50°C	-20° to 50°C	-20° to 50°C
Storage Temp.	-40° to 80°C	-40° to 80°C	-40° to 80°C	-40° to 80°C	-40° to 80°C
IP	IP67	IP67	IP67	IP67	IP67
Certificate	CE/ROHS	CE/ROHS	CE/ROHS	CE/ROHS	CE/ROHS

DMX LIGHT LINE DMX Light Line 18mm

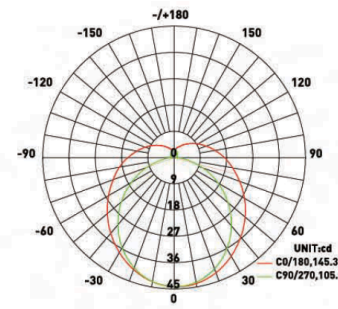
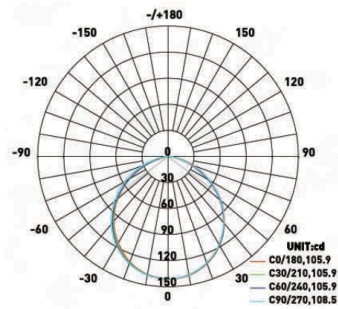
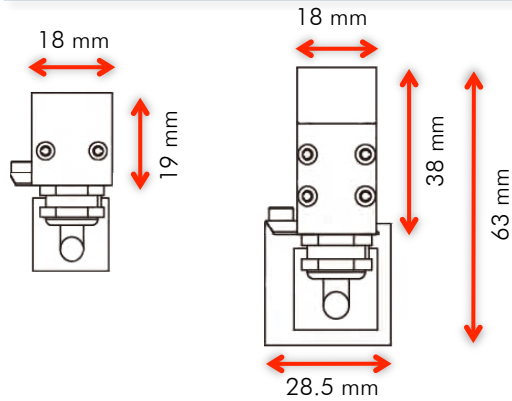

DL186001 DMX LIGHT LINE 18mm

SIZE: 39.37"x0.7"x0.74" (1000x18x19mm)

ORDER CODE: UNIALDL186001

DL181202 DMX LIGHT LINE 18mm

SIZE: 39.37"x0.7"x0.74" (1000x18x19mm)

ORDER CODE: UNIALDL181202

DL186003 DMX LIGHT LINE 18mm

SIZE: 39.37"x0.7"x0.74" (1000x18x19mm)

ORDER CODE: UNIALDL180603

DL186004 DMX LIGHT LINE 18mm

SIZE: 39.37"x0.7"x0.74" (1000x18x19mm)

ORDER CODE: UNIALDL186004

DLMS186003 DMX LIGHT LINE 18mm

SIZE: 39.37"x0.7"x1.49" (1000x18x38mm)

ORDER CODE: UNIALDLMS186003

ACCESSORIES

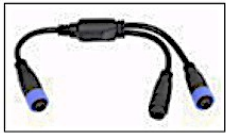

CONNECTION

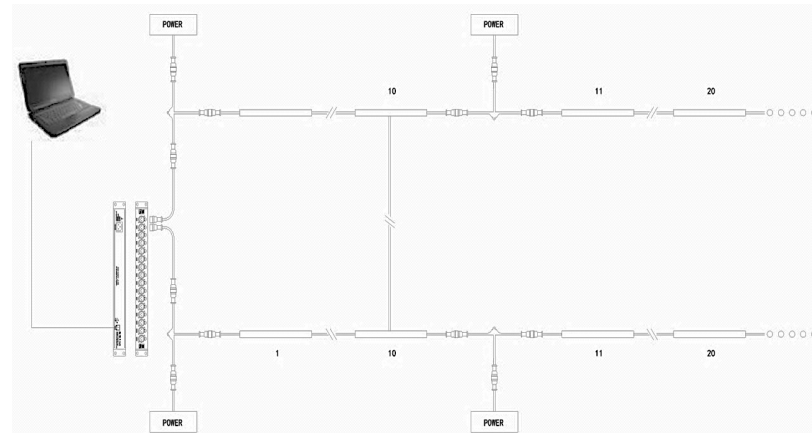

DMX LIGHT LINE DMX Light Line 28mm

FEATURES

- These DMX linear can be installed on the facade or in the ground of shopping center, bank and bridge, etc.
- Top brand Glue for better heatconduction, strong temperature withstand and perfect waterproof performance.
- High-brightness IPX6 SMD LED are assembled in this fixture.
- Apply solid capacitor of PCB for long life time.
- Save 40% power with more efficient power management design.
- Wide working voltage range DC12V-DC24V.
- Standard DMX512 control protocol (Max 44frames /second).
- DMX address can be set automatically and memorized also.
- The communication between led fixtures are synchronized perfectly under support of Artnet Controller.
- Protection: Hot pugging, and reverse connection.

DL286001 – DL281202 – DL286003 – DL286004 – DL283203 – DL284803
DMX LIGHT LINE 28mm

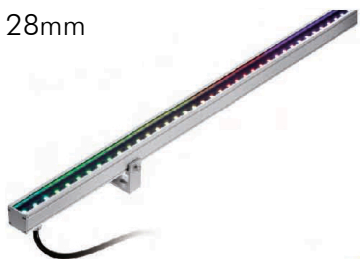

DLMF289601
DMX LIGHT LINE 28mm



DLMF289603
DMX LIGHT LINE 28mm



DLM286003 – DLM284803
DMX LIGHT LINE 28mm



DLMS286003
DMX LIGHT LINE 28mm



DMX LIGHT LINE

DMX Light Line 28mm

SPECIFICATIONS

	DL286001	DL281202	DL286003	DL286004	DLMS283203	DLMS284803
Size	1000x28x25 mm	1000x28x25 mm	1000x28x25 mm	1000x28x25 mm	1000x28x25 mm	1000x28x25 mm
Color	White2700K-5700K	Dynamic White 2700K-6000K	RGB	RGBW	RGB	RGB
Led	SDM 5050	SDM 5050	SDM 5050	SDM 5050	SDM 5050	SDM 5050
Led Q.ty	60	120	60	60	32	48
View angle	120°	120°	120°	360°	360°	360°
Voltage	24V DC	24V DC	24V DC	24V DC	24V DC	24V DC
Power	12W	12W	12W	12W	12W	12W
Control	On-Off/DMX 512	DMX 512	DMX 512	DMX 512	DMX 512	DMX 512
Address Setting	Auto/Manual	Auto/Manual	Auto/Manual	Auto/Manual	Auto/Manual	Auto/Manual
Pixel/m	1/2/4/5/10/20	1/2/4/5/10	1/2/4/5/10/20	1/2/4/5/10	1/8/16	1/2/4/8/16
Housing Color	Silver	Silver	Silver	Silver	Silver	Silver
Diffuser	Clear PC/ Dome Opal PC/Square Acrylic	Clear PC/ Dome Opal PC	Clear PC/ Dome Opal PC	Clear PC/ Dome Opal PC	Clear PC/ Dome Opal PC	Clear PC/ Dome Opal PC
Cable Entry	Bottom/Side	Bottom/Side	Bottom/Side	Bottom/Side	Bottom/Side	Bottom/Side
Operating Temp	-20° to 50°C	-20° to 50°C	-20° to 50°C	-20° to 50°C	-20° to 50°C	-20° to 50°C
Storage Temp.	-40° to 80°C	-40° to 80°C	-40° to 80°C	-40° to 80°C	-40° to 80°C	-40° to 80°C
IP	IP67	IP67	IP67	IP67	IP67	IP67
Certificate	CE/ROHS	CE/ROHS	CE/ROHS	CE/ROHS	CE/ROHS	CE/ROHS

SPECIFICATIONS

	DLM286003	DLM284803	DLMS286003	DLMF2896001	DLMFS289603
Size	1000x28x27.4 mm	1000x28x27.4 mm	1000x28x38 mm	1000x28x38 mm 1000x35x69 mm with brackets	1000x28x35 mm
Color	RGB	RGB	RGB	White2700K-5700K	RGB
Led	SDM 5050	SDM 5050	SDM 5050	SDM 5050	SDM 5050
Led Q.ty	60	48	60	96	96
View angle	120°	120°	120°	120°	120°
Voltage	24V DC	24V DC	24V DC	24V DC	24V DC
Power	12W	12W	12W	12W	12W
Control	DMX 512	DMX 512	DMX 512	On-Off/DMX 512	DMX 512
Address Setting	Auto/Manual	Auto/Manual	Auto/Manual	Auto/Manual	Auto/Manual
Pixel/m	1/2/4/5/10/20	8/16	1/2/4/5/10	1/2/4/8/16/32	1/2/4/8/16/32
Housing Color	Silver	Silver	Silver	Silver	Silver
Diffuser	Opal PC	Opal PC	Square Opal PC	Opal	Opal
Cable Entry	Bottom	Bottom	Bottom	Bottom	Bottom
Operating Temp.	-20° to 50°C	-20° to 50°C	-20° to 50°C	-20° to 50°C	-20° to 50°C
Storage Temp.	-40° to 80°C	-40° to 80°C	-40° to 80°C	-40° to 80°C	-40° to 80°C
IP	IP67	IP67	IP67	IP67	IP67
Certificate	CE/ROHS	CE/ROHS	CE/ROHS	CE/ROHS	CE/ROHS

DMX LIGHT LINE DMX Light Line 28mm

DL28XXXX

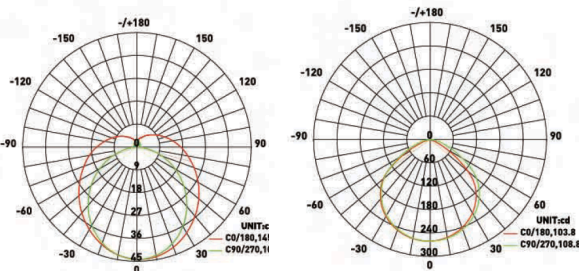
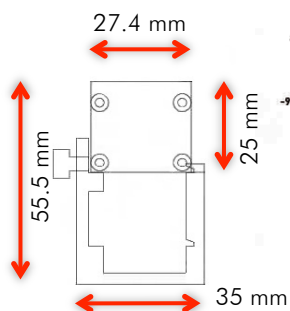

DLM286003 DMX LIGHT LINE 28mm

SIZE: 39.37"x1.1"x1.43"(1000x28x36.4mm)

ORDER CODE: UNIALDLM286003

DLM284803 DMX LIGHT LINE 28mm

SIZE: 39.37"x1.1"x1.43"(1000x28x36.4mm)

ORDER CODE: UNIALDLM284803

DLM28XXXX

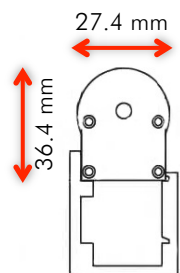

DLMS28XXXX

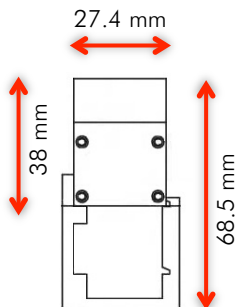

DLMF28XXXX

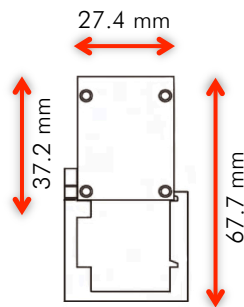

DLMS286003 DMX LIGHT LINE 28mm

SIZE: 39.37"x1.1"x1.49"(1000x28x38mm)

ORDER CODE: UNIALDLM286003

DLMF289601 DMX LIGHT LINE 28mm

SIZE: 39.37"x1.1"x1.49"(1000x28x38mm)

ORDER CODE: UNIALDLMF289601

DLMF289603 DMX LIGHT LINE 28mm

SIZE: 39.37"x1.1"x1.37"(1000x28x35mm)

ORDER CODE: UNIALDLMF289603

DL286001 DMX LIGHT LINE 28mm

SIZE: 39.37"x1.1"x0.98"(1000x28x25mm)

ORDER CODE: UNIALDL286001

DL281202 DMX LIGHT LINE 28mm

SIZE: 39.37"x1.1"x0.98"(1000x28x25mm)

ORDER CODE: UNIALDL281202

DL286003 DMX LIGHT LINE 28mm

SIZE: 39.37"x1.1"x0.98"(1000x28x25mm)

ORDER CODE: UNIALDL286003

DL186004 DMX LIGHT LINE 18mm

SIZE: 39.37"x1.1"x0.98"(1000x28x25mm)

ORDER CODE: UNIALDL186004

DL283203 DMX LIGHT LINE 28mm

SIZE: 39.37"x1.1"x0.98"(1000x28x25mm)

ORDER CODE: UNIALDL283203

DL284803 DMX LIGHT LINE 28mm

SIZE: 39.37"x1.1"x0.98"(1000x28x25mm)

ORDER CODE: UNIALDL284803

ACCESSORIES



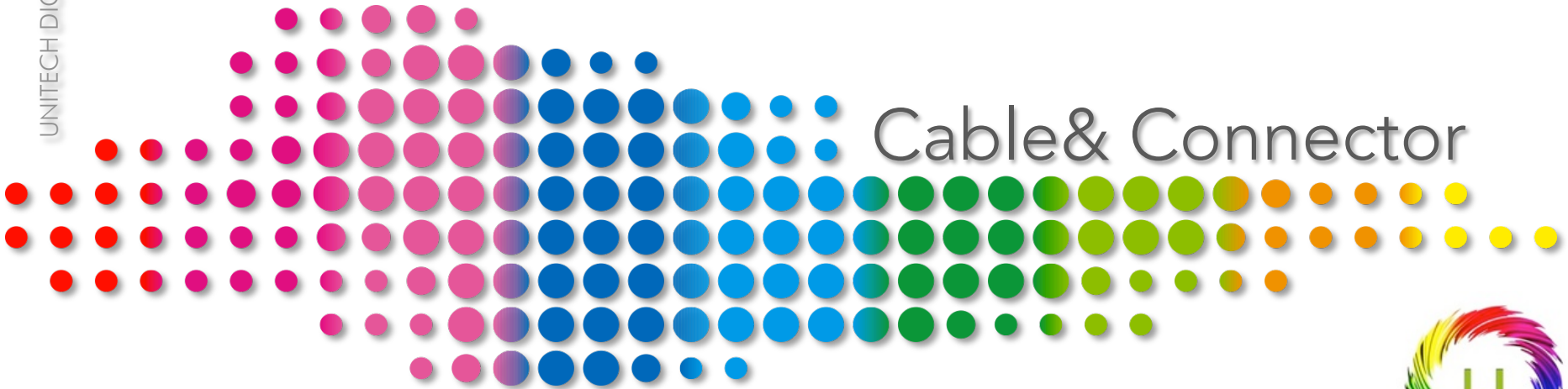

Cable & Connector



Cable & Connector

IP67 CONNECTOR PUSH LOCK



4PIN Extension Cable 67E4M4F
ORDER CODE: UNICPL67EM4F



T Connector for Signal&Power 67T5XM4F2M
ORDER CODE: UNICPL67T5XM4F2M



T Connector for Power 67T4M4F2M
ORDER CODE: UNICPL67T4M4F2M



2PIN Power Cable 67E2FB
ORDER CODE: UNICPL67E2FB

IP67 CONNECTOR SCREW LOCK



2PIN Power Cable 67E2FB
ORDER CODE: UNICSL67E2FB



T Connector for Signal&Power 67T5XM4F2M
ORDER CODE: UNICSL67T5XM4F2M



T Connector for Power 67T4M4F2M
ORDER CODE: UNICSL67T4M4F2M

IP65 CONNECTOR SCREW LOCK



2PIN Power Cable 65E2FB
ORDER CODE: UNICSL65E2FB



T Connector for Signal&Power 65T5XM4F2M
ORDER CODE: UNICSL65T5XM4F2M



T Connector for Power 65T4M4F2M
ORDER CODE: UNICSL65T4M4F2M



T Connector for LED Fixture 65T4M4F4F
ORDER CODE: UNICSL65T4M4F4F

NO WATERPROOF CONNECTOR



5PIN XLR Female – CD – XLR5F
ORDER CODE: UNINWCXLR5F



5PIN XLR Male – CD – XLR5M
ORDER CODE: UNINWCXLR5M



3PIN XLR Female – CD – XLR3F
ORDER CODE: UNINWCXLR3F



3PIN XLR Male – CD – XLR3M
ORDER CODE: UNIAC67E2FB



T Connector for Signal&Power
NWT5XM4F2M
ORDER CODE: UNINWT5XM4F2M



4PIN Extension Cable NWE4M4F
ORDER CODE: UNINWE4M4F



Signal Cable NWE5XM3SF
ORDER CODE: UNINWE5XM3SF

Power Supply

LRS



LRS Power Supply

ORDER CODE: UNIPSLRS150

Wattage	LRS 150W
Features	Economical non-PFC models Miniature size with complete protections Most economical models with complete safety certificates
DC Voltage	DC12V DC24V

SP



SP Power Supply

ORDER CODE: UNIPSSP150

Wattage	SP 150W
Features	Built-in active PFC function Full range input, complete functions
DC Voltage	DC12V DC24V

HLG



HLG Power Supply

ORDER CODE: UNIPSHLG150

Wattage	HQ 150W
Features	90-305VAC input, built-in active PFC function Metal case, IP67/IP65 design for indoor or outdoor installations
DC Voltage	DC12V DC24V