

Linear Light

Indoor Architectural Lighting



Linear light

LED linear light with can meet all kinds of lighting demands.



Linear Light

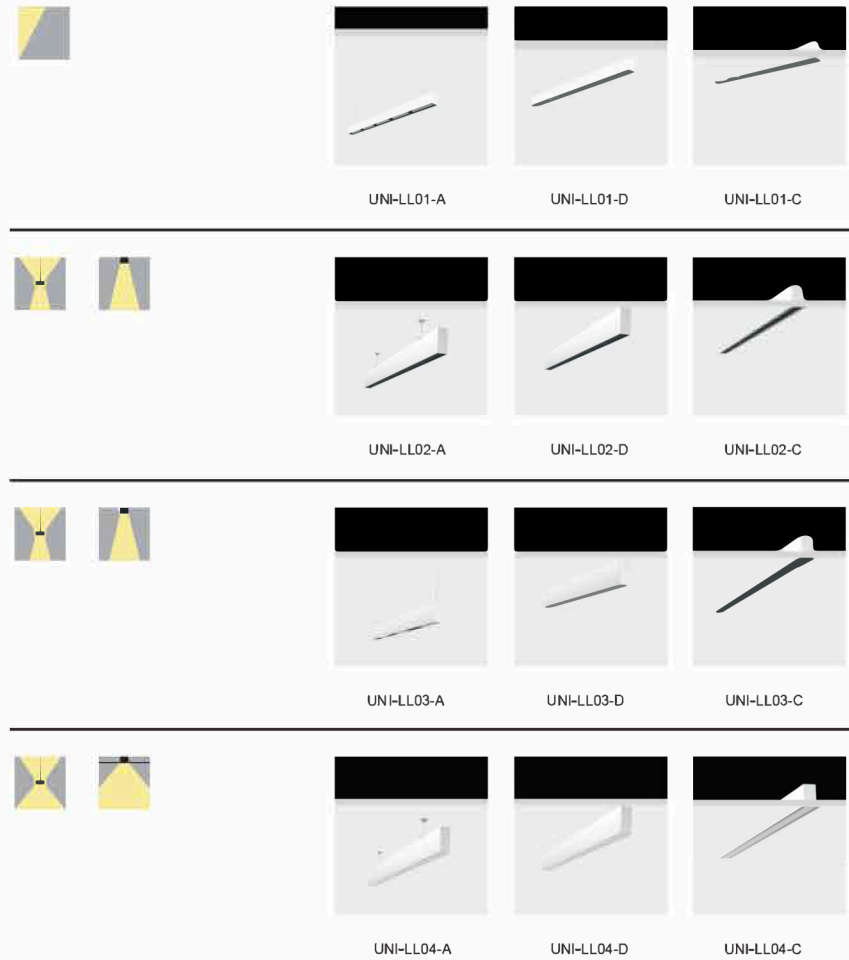

LL 01 Series Wall Washer

Linear Series



Luminous ways



Installation methods

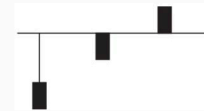

Power

5W/18W/30W/36W

CCT

3000K
4000K
5000K

Body Finish

Black ■
White ■
Silver ■

Length(m)

Lifting/Surface mounted/Recessed/Track
 130mm
 600mm
 1200mm
 1500mm

Size(mm)

Lifting:
 137mm*33mm*41mm
 669mm*33mm*41mm
 1200mm*33mm*41mm
 1467mm*33mm*41mm

Recessed:
 137mm*33mm*41mm
 669mm*33mm*41mm
 1200mm*33mm*41mm
 1467mm*33mm*41mm

Surface mounted:
 137mm*33mm*41mm
 669mm*33mm*41mm
 1200mm*33mm*41mm
 1467mm*33mm*41mm

Track:
 669mm*33mm*83mm
 1200mm*33mm*83mm
 1467mm*33mm*83mm

Section drawing (mm)

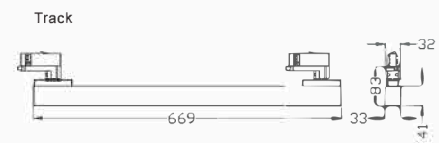
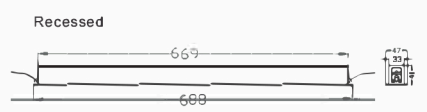
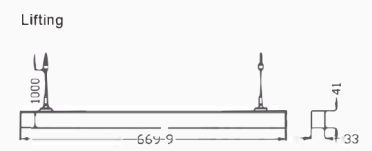

Linear Light

LL 02 Series Linear Light



Linear Light



Section drawing (mm)

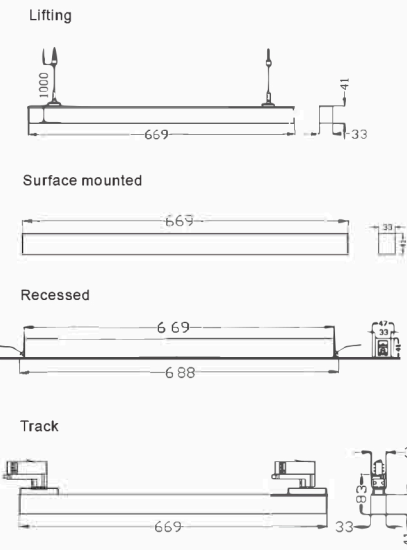

Linear Series

Luminous ways

Installation methods

Power
 6W/18W/30W/36W

Beam angle

 10° 24° 36° 48° 60°

CCT
 3000K
 4000K
 5000K

Body Finish
 Black 
 White 
 Silver 

Length(mm)
 Lifting/Surface mounted/Recessed/Track

 130mm
 600mm
 1200mm
 1500mm

Size(mm)

Lifting: 137mm*33mm*41mm 669mm*33mm*41mm 1200mm*33mm*41mm 1467mm*33mm*41mm	Surface mounted: 137mm*33mm*41mm 669mm*33mm*41mm 1200mm*33mm*41mm 1467mm*33mm*41mm
Recessed: 137mm*33mm*41mm 669mm*33mm*41mm 1200mm*33mm*41mm 1467mm*33mm*41mm	Track: 669mm*33mm*83mm 1200mm*33mm*83mm 1467mm*33mm*83mm

LL 03 Series Linear Light



Linear Series



Luminous ways



Installation methods

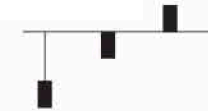

Power

9W/15W/18W

Beam angle

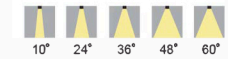

CCT

3000K
4000K
5000K

Body Finish

Black ■
White ■
Silver ■

Length(mm)

Lifting/Surface mounted/Recessed/Track

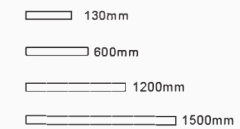

Size(mm)

Lifting:	669mm*33mm*41mm	Surface mounted:	669mm*33mm*41mm
	1200mm*33mm*41mm		1200mm*33mm*41mm
	1467mm*33mm*41mm		1467mm*33mm*41mm
Recessed:	669mm*33mm*41mm	Track:	669mm*33mm*83mm
	1200mm*33mm*41mm		1200mm*33mm*83mm
	1467mm*33mm*41mm		1467mm*33mm*83mm

Section drawing (mm)

Lifting

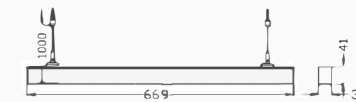

Surface mounted



Recessed

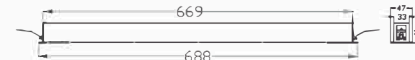

Track



Linear Light

LL 04 Series Linear Light



Linear Light

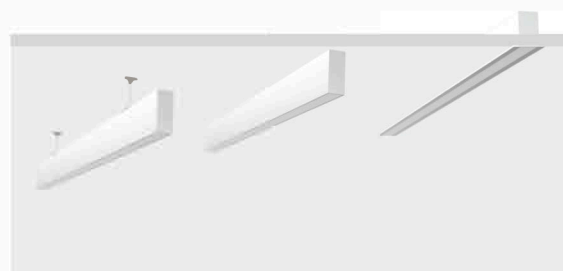

Section drawing (mm)

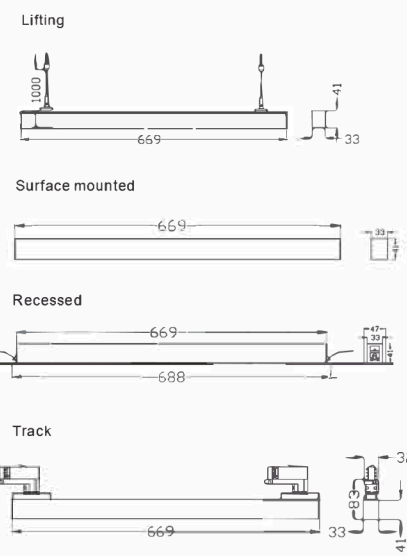

Linear Series

Luminous ways



Installation methods

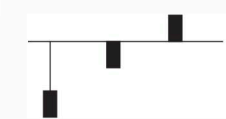

Power

6W/18W/30W/36W

Beam angle



120°





CCT

3000K
4000K
5000K

Body Finish

Black 
White 
Silver 

Length(mm)

- Lifting/Surface mounted/Recessed/Track
-  130mm
 -  600mm
 -  1200mm
 -  1500mm

Size(mm)

Lifting:	Surface mounted:
137mm*33mm*41mm	137mm*33mm*41mm
669mm*33mm*41mm	669mm*33mm*41mm
1200mm*33mm*41mm	1200mm*33mm*41mm
1467mm*33mm*41mm	1467mm*33mm*41mm
Recessed:	Track:
137mm*33mm*41mm	669mm*33mm*83mm
669mm*33mm*41mm	1200mm*33mm*83mm
1200mm*33mm*41mm	1467mm*33mm*83mm
1467mm*33mm*41mm	



	UNI-LL01	UNI-LL02	UNI-LL03	UNI-LL04
Optics				
Wall Washer	•			
Narrow 10°		•	•	
Medium 24°		•	•	
Wide 36°		•	•	
Flood 48°		•	•	
Wide Flood 60°		•	•	
Wide Flood 120°				•
Power				
5W	•			
6W		•		•
9W			•	
15W			•	
18W	•	•	•	•
30W	•	•		•
36W	•	•		•
Colour				
White	•	•	•	•
Black	•	•	•	•
Silver	•	•	•	•
LED Brand				
Seoul	•	•	•	•
Size				
137mm*33mm*41mm	•	•		•
669mm*33mm*41mm	•	•	•	•
1200mm*33mm*41mm	•	•	•	•
1487mm*33mm*41mm	•	•	•	•
669mm*33mm*83mm	•	•	•	•
1200mm*33mm*83mm	•	•	•	•
1487mm*33mm*83mm	•	•	•	•
Flow obviously refers to				
3000K Ra>92	•	•	•	•
4000K Ra>92	•	•	•	•
6000K Ra>92	•	•	•	•
3000K Ra>82	•	•	•	•
4000K Ra>82	•	•	•	•
6000K Ra>82	•	•	•	•
Installation				
Recessed	•	•	•	•
Surface Mountde	•	•	•	•
Pendant	•	•	•	•
Track	•	•	•	•

Notes

- Different wattages can be provided upon request
- Customization for non-standard solutions in terms of light source, color, length and other specifications.